

Easy isolation from various samples

- Appropriate kit selectable depending on sample.

SPECIFIC ISOLATION KITS

- QuickGene isolation kits are optimized for the system to isolate DNA and RNA in the shortest time and with the highest quality.
- Environmentally friendly isolation can be conducted without using hazardous organic solvents.

	Samples	Isolation kits	Reference code	Isolation Time	Isolation example
For DNA Isolation	Human/Animal whole blood (EDTA blood, heparin blood), Buffy coat, Plasma, Serum	DNA whole blood kit S	DB-S [For 96 samples]	45 min / 48 samples	ca.5μg / 200μl whole blood
	Animal tissue, Plants, Insects, Fish and Shellfish, Cheek swab, Paraffin-embedded samples, Cultured cells, Bacteria, Virus, Materials, manufactured goods	DNA tissue kit S	DT-S [For 96 samples]	50 min / 48 samples	ca.4μg / 5mg Balb/c Mouse tail
	Plasmid	Plasmid kit S II	PL-S2 [For 96 samples]	40 min / 48 samples	ca.12.5μg / 1ml culture pBlueScript II/GAPDH/DH5a
For RNA Isolation	Animal tissue, Insects, Virus, etc.	RNA tissue kit S II	RT-S2 [For 96 samples]	60 min / 48 samples	ca.100μg / 30mg Mouse liver
	Adherent / Non-adherent cultured cell (Hela, HL60, etc.); Plant tissue, etc.	RNA cultured cell kit S	RC-S [For 96 samples]	60 min / 48 samples	ca.10μg / 1 × 10 ⁶ cells HL60 cell
	Cultured cell on 6/10cm dish (Maximum number of cells is 1 × 10 ⁶)	RNA cultured cell HC kit S	RC-S2 [For 96 samples]	60 min / 48 samples	90~150μg / 10cm dish cultured HEK293 cell
	Leukocytes separated by Ammonium chloride Erythrocytes of whole blood or Ficoll fraction	RNA blood cell kit S	RB-S [For 96 samples]	70 min / 48 samples	ca.4.5μg / 1 × 10 ⁷ cells Leukocytes

*The kits are not supplied with QuickGene-Mini480. Select the desired kit(s) and order it(them) separately.
*Isolation time does not include the process of sample pretreatment.

QuickGene-Mini480 Specifications

Overview

- Throughput : 1 to 48 samples per run

Physical specifications

- Dimensions : 280(W)×260(D)×300(H) mm
- Weight : Approx. 3.3kg

Operating conditions

- Supply voltage : AC100~240V
- Power supply frequency : 50 / 60 Hz
- Operating conditions : Temperature: 15~30°C
: Humidity: 30~80% (non-condensing)

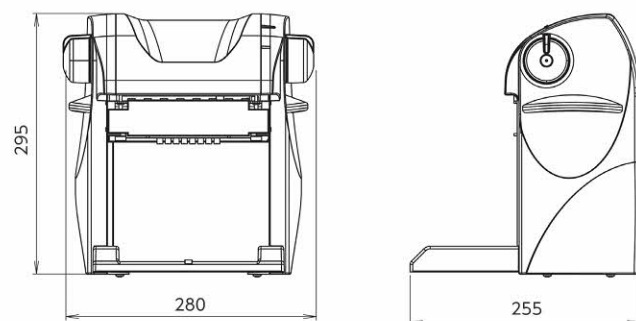

*Research use only

All brand names and product names are trademarks or registered trademarks of their respective companies. Design and specifications are subject to change without notice.



KURABO INDUSTRIES LTD. Bio-Medical Department
14-5, Shimokida-cho, Neyagawa-shi, Osaka 572-0823, Japan
Phone: +81-72-820-3079 FAX: +81-72-820-3095
Email: bio@ad.kurabo.co.jp
www.kurabo.co.jp/bio/English/



Nucleic Acid Isolation System

QuickGene-Mini480

One For Each Person



Personal nucleic acid isolation device, one for each person

maximum throughput, up to 48 samples!!!

QuickGene-Mini480 is a high-throughput compact system requiring no centrifugation in the isolation process, giving less strain to samples and enabling rapid nucleic acid isolation. DNA/RNA can be easily isolated from various samples including whole blood/tissue/cells/plants/virus and others.



Compact design

- The small, lightweight QuickGene-Mini480 takes up minimal space on the lab bench and is easy to carry.
- No need to move the samples from the lab bench without centrifugation throughout the whole isolation process.

Revolutionary Porous Membrane

- The QuickGene-Mini480 uses patented porous membrane only 80µm thick.
- Depending on the outstanding adsorption/desorption performances of the membrane, high-purity nucleic acid can be easily obtained in high yield at low pressure.
- The ultra thin membrane enables nucleic acid isolation in shorter time than when compared to glass fiber membranes.

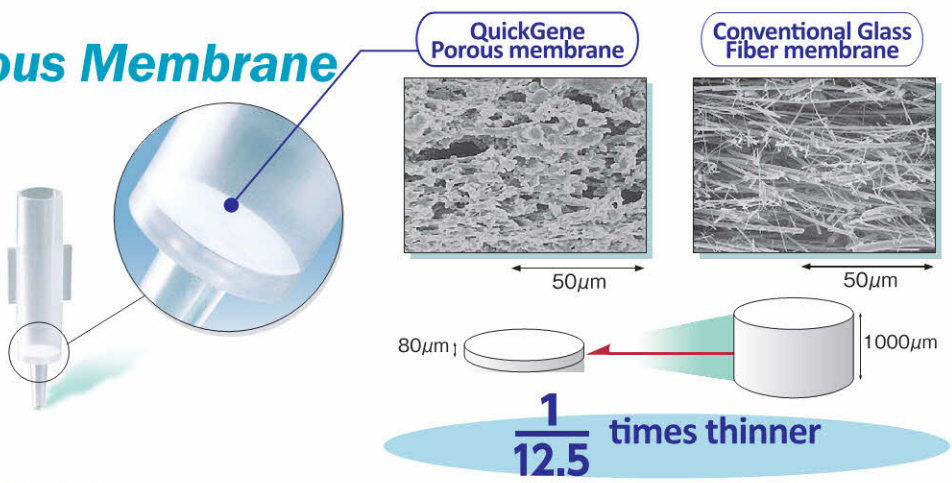

High Purity, High Yield

- QuickGene-Mini480 can stably isolate nucleic acid in high yield.
- The isolated DNA/RNA can be directly applied to PCR, RT-PCR, Next Generation Sequencing Analysis, etc.

DNA isolation from whole blood

• QuickGene DNA whole blood kit S (DB-S) • Human whole blood 200µl (8×10⁵ cell leukocytes)

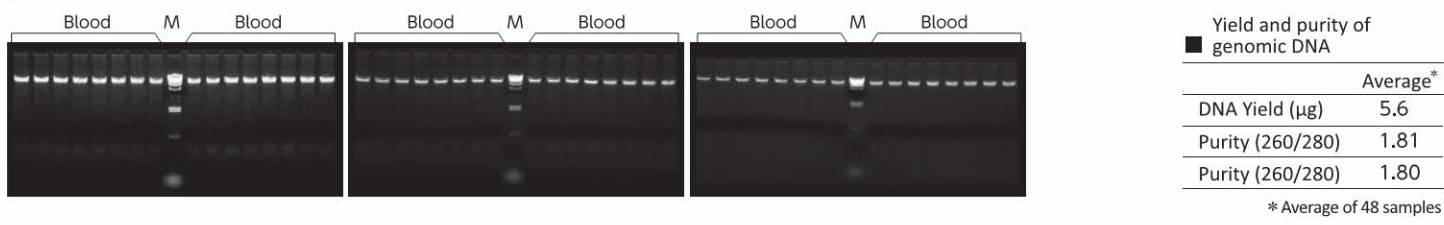

DNA isolation from mouse tissue

• QuickGene DNA tissue kit S (DT-S) • Balb/C mouse (♀) liver 10mg

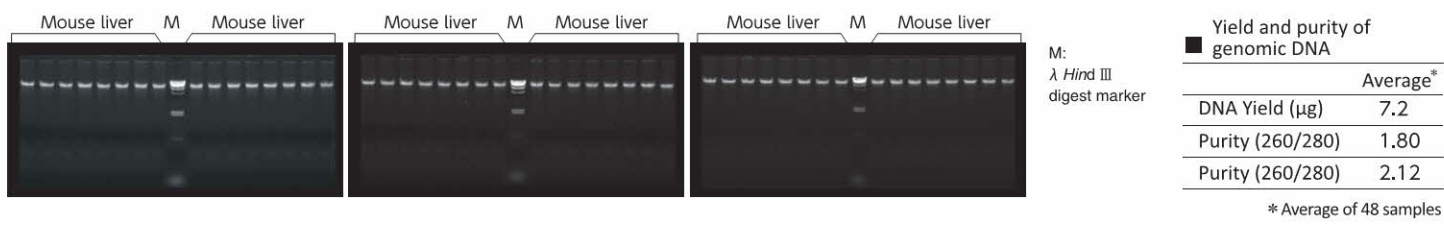

RNA isolation from cultured cells

• QuickGene RNA cultured cell kit S (RC-S) • HeLa S3 Cell (1×10⁶ cells)

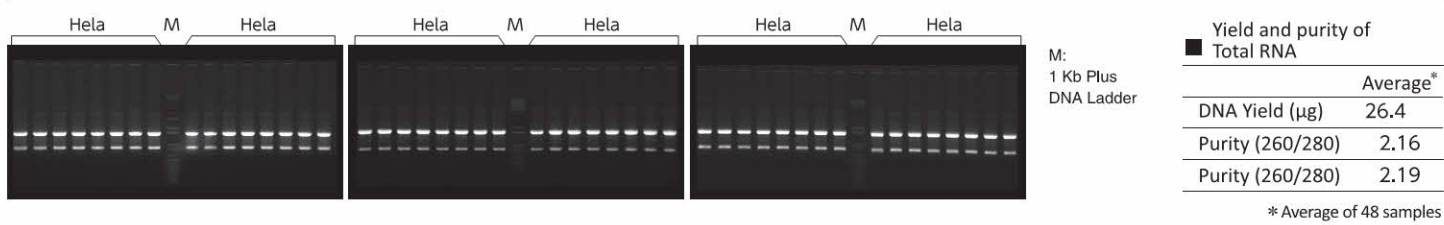

Easy & Rapid Processing

- The operation is simple. Just set the sample and rotate the grey pressurizing Rotary Switch on both side of the device.
- No centrifugation process, no need to remove and transfer the liquid after sample pre-treatment to save valuable time.
- Process 1 to 48 samples per run. And enhance usability by using Multichannel Pipettes. (NEW)

Pressurizing Process

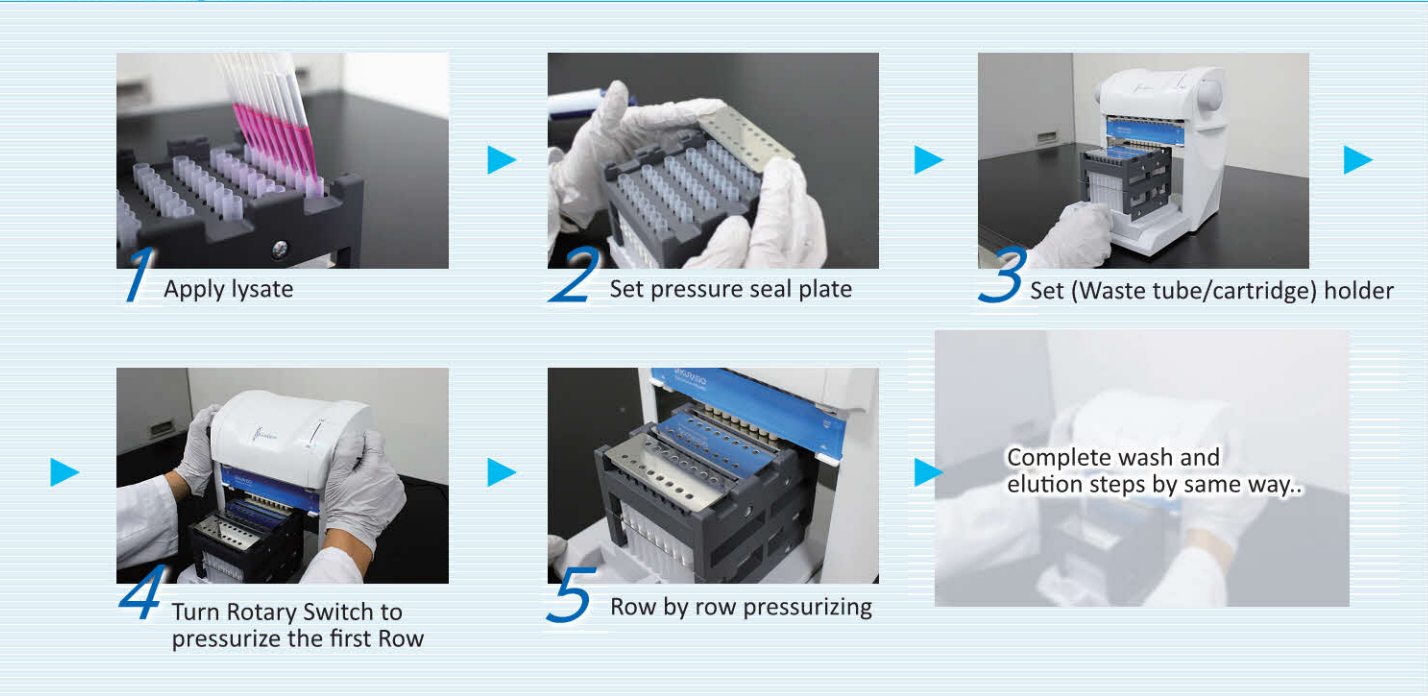

Workflow of isolation using DNA whole blood kit

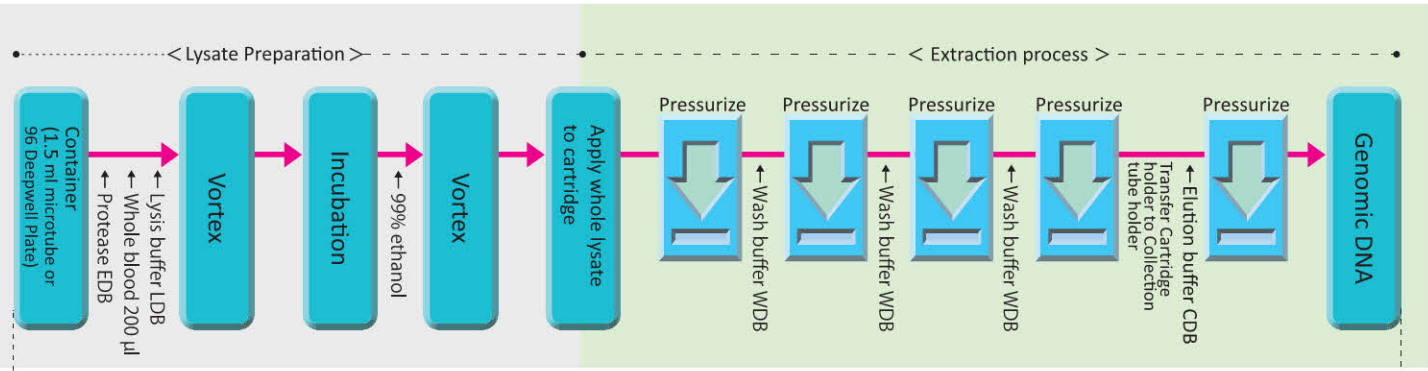

Processing time < 90min / 48 samples

※ Including sample pretreatment time
 ※ In case of using DB-S kit, 96 Deepwell Plates and Multichannel Pipettes.

- Pressurizing process
- 1) Set holder into system
 - 2) Rotate pressurizing switch toward the front side to start pressurizing
 - 3) Make sure that there is no residual liquid in the cartridge and return the pressurizing switch to original position
 - 4) Pull out holder from system